

# BSS138L, BVSS138L

## Power MOSFET 200 mA, 50 V

### N-Channel SOT-23

Typical applications are DC-DC converters, power management in portable and battery-powered products such as computers, printers, PCMCIA cards, cellular and cordless telephones.

#### Features

- Low Threshold Voltage ( $V_{GS(th)}$ : 0.85 V–1.5 V) Makes it Ideal for Low Voltage Applications
- Miniature SOT-23 Surface Mount Package Saves Board Space
- BVSS Prefix for Automotive and Other Applications Requiring Unique Site and Control Change Requirements; AEC-Q101 Qualified and PPAP Capable
- These Devices are Pb-Free, Halogen Free/BFR Free and are RoHS Compliant

#### MAXIMUM RATINGS ( $T_A = 25^\circ\text{C}$ unless otherwise noted)

Rating	Symbol	Value	Unit
Drain-to-Source Voltage	$V_{DSS}$	50	Vdc
Gate-to-Source Voltage - Continuous	$V_{GS}$	$\pm 20$	Vdc
Drain Current			mA
- Continuous @ $T_A = 25^\circ\text{C}$	$I_D$	200	
- Pulsed Drain Current ( $t_p \leq 10 \mu\text{s}$ )	$I_{DM}$	800	
Total Power Dissipation @ $T_A = 25^\circ\text{C}$	$P_D$	225	mW
Operating and Storage Temperature Range	$T_J, T_{stg}$	- 55 to 150	$^\circ\text{C}$
Thermal Resistance, Junction-to-Ambient	$R_{\theta JA}$	556	$^\circ\text{C/W}$
Maximum Lead Temperature for Soldering Purposes, for 10 seconds	$T_L$	260	$^\circ\text{C}$

Stresses exceeding those listed in the Maximum Ratings table may damage the device. If any of these limits are exceeded, device functionality should not be assumed, damage may occur and reliability may be affected.



ON Semiconductor®

[www.onsemi.com](http://www.onsemi.com)

200 mA, 50 V  
 $R_{DS(on)} = 3.5 \Omega$

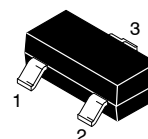
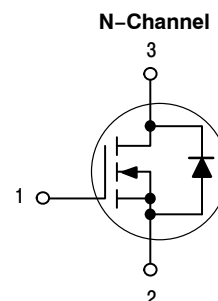

SOT-23  
CASE 318  
STYLE 21

#### MARKING DIAGRAM

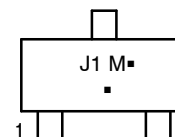

J1 = Device Code  
M = Date Code\*  
▪ = Pb-Free Package

(Note: Microdot may be in either location)

\*Date Code orientation and/or overbar may vary depending upon manufacturing location.

#### ORDERING INFORMATION

Device	Package	Shipping†
BSS138LT1G, BVSS138LT1G	SOT-23 (Pb-Free)	3,000 / Tape & Reel
BSS138LT7G	SOT-23 (Pb-Free)	3,500 / Tape & Reel
BSS138LT3G, BVSS138LT3G	SOT-23 (Pb-Free)	10,000 / Tape & Reel

†For information on tape and reel specifications, including part orientation and tape sizes, please refer to our Tape and Reel Packaging Specifications Brochure, BRD8011/D.

# BSS138L, BVSS138L

## ELECTRICAL CHARACTERISTICS ( $T_A = 25^\circ\text{C}$ unless otherwise noted)

Characteristic	Symbol	Min	Typ	Max	Unit
----------------	--------	-----	-----	-----	------

### OFF CHARACTERISTICS

Drain-to-Source Breakdown Voltage ( $V_{GS} = 0\text{ Vdc}$ , $I_D = 250\ \mu\text{Adc}$ )	$V_{(BR)DSS}$	50	-	-	Vdc
Zero Gate Voltage Drain Current ( $V_{DS} = 25\text{ Vdc}$ , $V_{GS} = 0\text{ Vdc}$ , $25^\circ\text{C}$ ) ( $V_{DS} = 50\text{ Vdc}$ , $V_{GS} = 0\text{ Vdc}$ , $25^\circ\text{C}$ ) ( $V_{DS} = 50\text{ Vdc}$ , $V_{GS} = 0\text{ Vdc}$ , $150^\circ\text{C}$ )	$I_{DSS}$	-	-	0.1 0.5 5.0	$\mu\text{Adc}$
Gate-Source Leakage Current ( $V_{GS} = \pm 20\text{ Vdc}$ , $V_{DS} = 0\text{ Vdc}$ )	$I_{GSS}$	-	-	$\pm 0.1$	$\mu\text{Adc}$

### ON CHARACTERISTICS (Note 1)

Gate-Source Threshold Voltage ( $V_{DS} = V_{GS}$ , $I_D = 1.0\text{ mAdc}$ )	$V_{GS(th)}$	0.85	-	1.5	Vdc
Static Drain-to-Source On-Resistance ( $V_{GS} = 2.75\text{ Vdc}$ , $I_D < 200\text{ mAdc}$ , $T_A = -40^\circ\text{C}$ to $+85^\circ\text{C}$ ) ( $V_{GS} = 5.0\text{ Vdc}$ , $I_D = 200\text{ mAdc}$ )	$r_{DS(on)}$	-	5.6	10 3.5	$\Omega$
Forward Transconductance ( $V_{DS} = 25\text{ Vdc}$ , $I_D = 200\text{ mAdc}$ , $f = 1.0\text{ kHz}$ )	$g_{fs}$	100	-	-	mmhos

### DYNAMIC CHARACTERISTICS

Input Capacitance	( $V_{DS} = 25\text{ Vdc}$ , $V_{GS} = 0$ , $f = 1\text{ MHz}$ )	$C_{iss}$	-	40	50	pF
Output Capacitance	( $V_{DS} = 25\text{ Vdc}$ , $V_{GS} = 0$ , $f = 1\text{ MHz}$ )	$C_{oss}$	-	12	25	
Transfer Capacitance	( $V_{DG} = 25\text{ Vdc}$ , $V_{GS} = 0$ , $f = 1\text{ MHz}$ )	$C_{rss}$	-	3.5	5.0	

### SWITCHING CHARACTERISTICS (Note 2)

Turn-On Delay Time	(V <sub>DD</sub> = 30 Vdc, I <sub>D</sub> = 0.2 Adc.)	$t_{d(on)}$	-	-	20	ns
Turn-Off Delay Time		$t_{d(off)}$	-	-	20	

Product parametric performance is indicated in the Electrical Characteristics for the listed test conditions, unless otherwise noted. Product performance may not be indicated by the Electrical Characteristics if operated under different conditions.

1. Pulse Test: Pulse Width  $\leq 300\ \mu\text{s}$ , Duty Cycle  $\leq 2\%$ .
2. Switching characteristics are independent of operating junction temperature.

TYPICAL ELECTRICAL CHARACTERISTICS

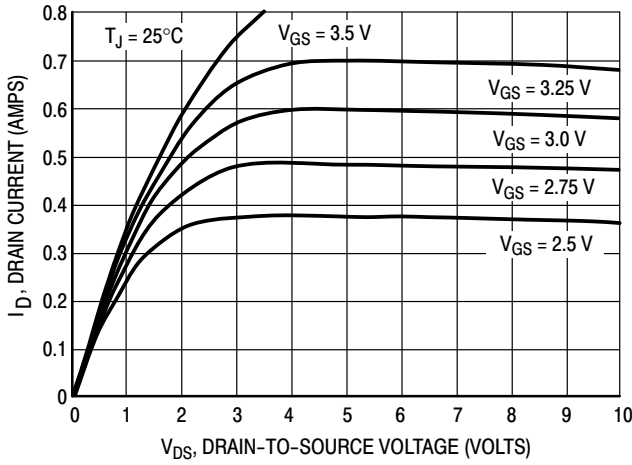

Figure 1. On-Region Characteristics

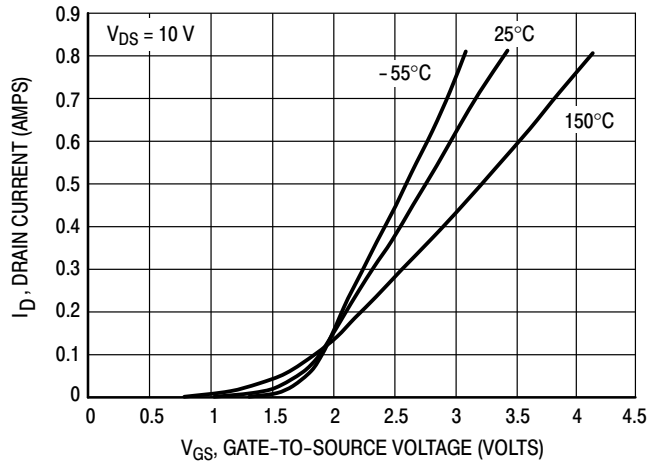

Figure 2. Transfer Characteristics

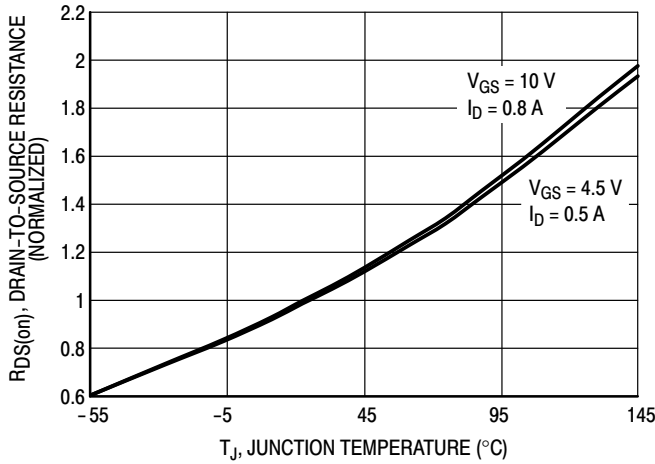

Figure 3. On-Resistance Variation with Temperature

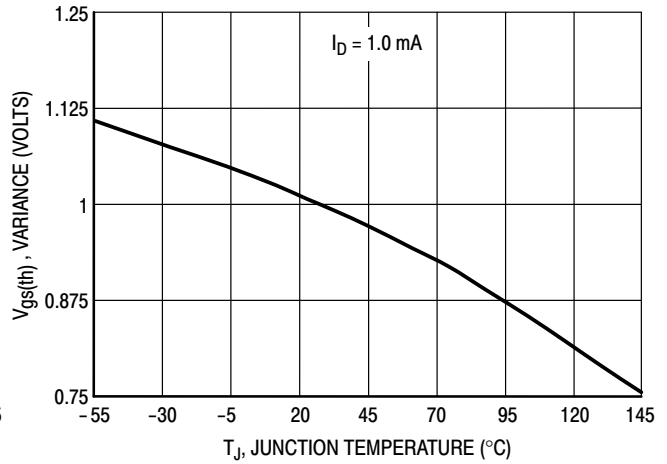

Figure 4. Threshold Voltage Variation with Temperature

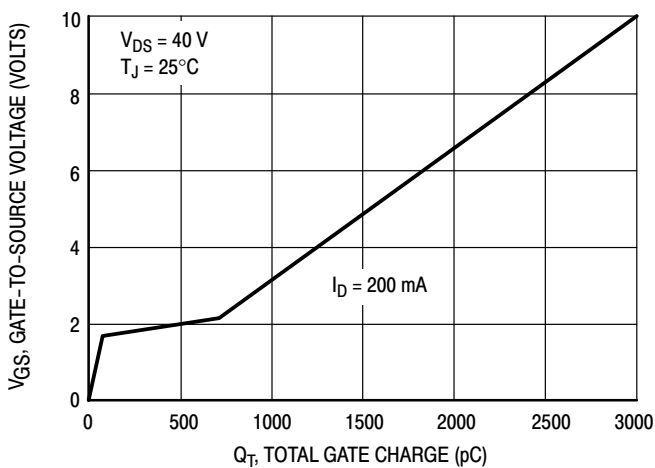

Figure 5. Gate Charge

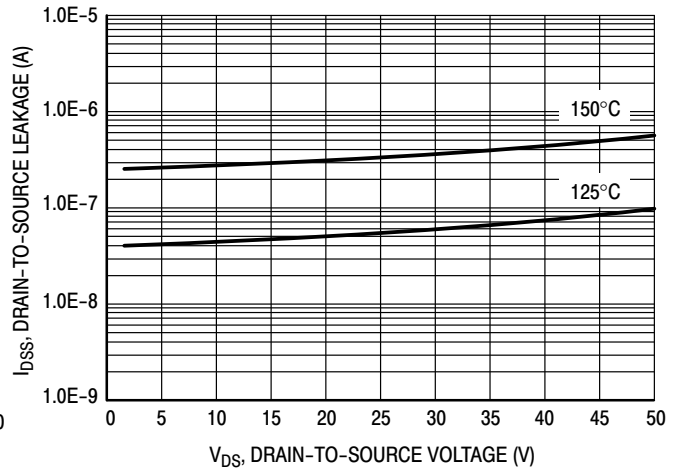

Figure 6. IDSS

# BSS138L, BVSS138L

## TYPICAL ELECTRICAL CHARACTERISTICS

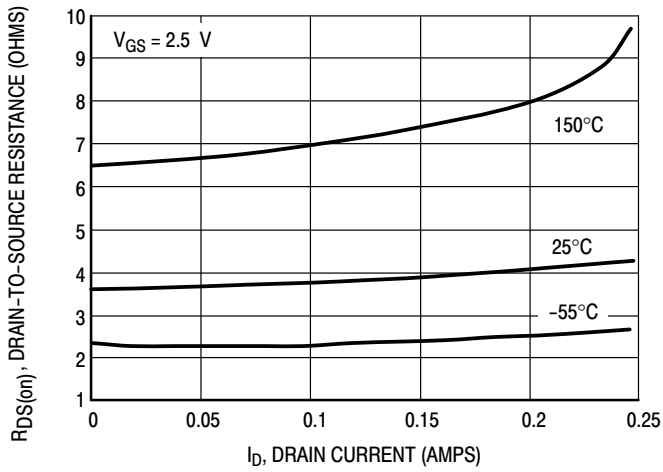

Figure 7. On-Resistance versus Drain Current

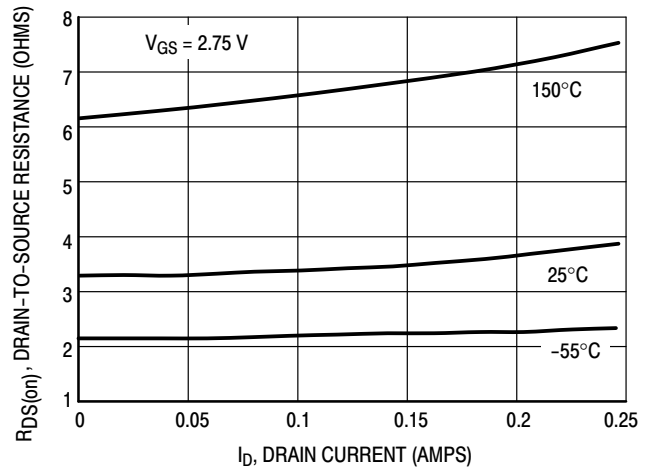

Figure 8. On-Resistance versus Drain Current

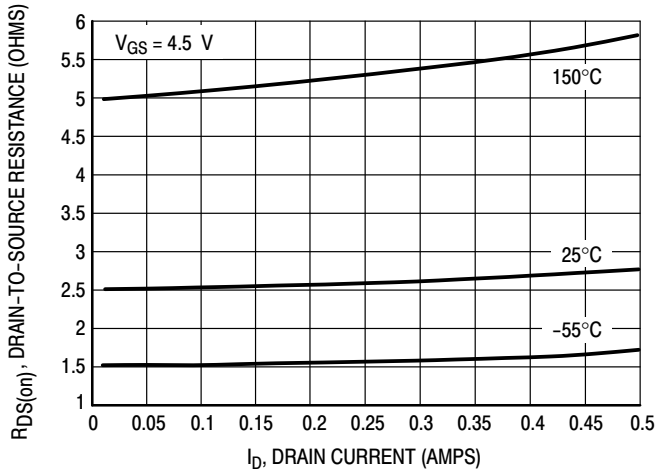

Figure 9. On-Resistance versus Drain Current

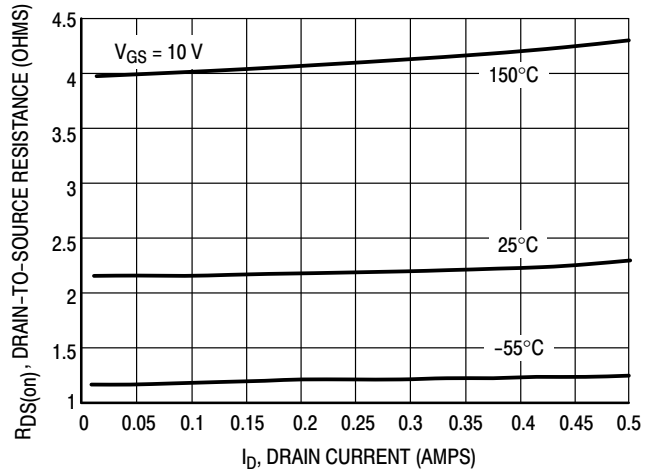

Figure 10. On-Resistance versus Drain Current

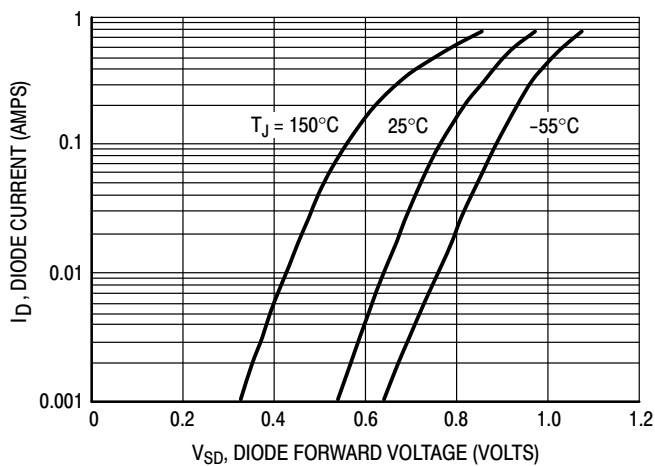

Figure 11. Body Diode Forward Voltage

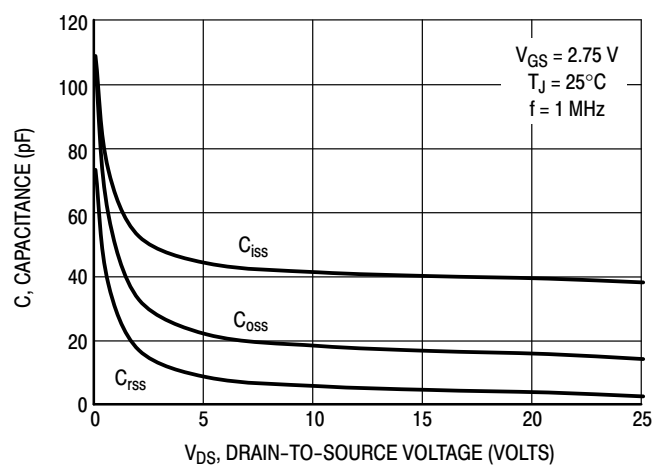
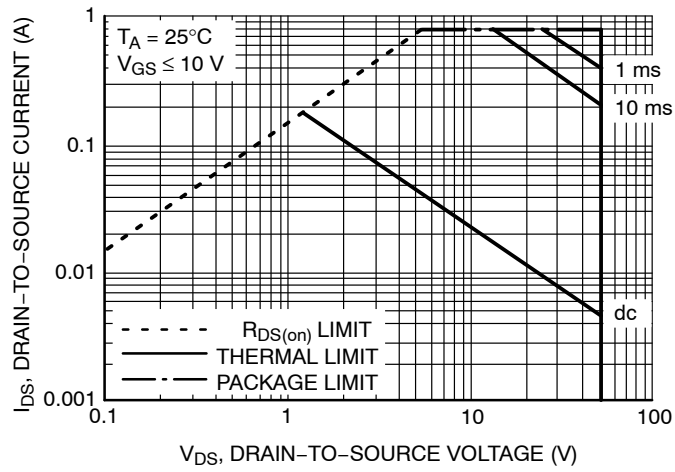

Figure 12. Capacitance

# BSS138L, BVSS138L

## TYPICAL ELECTRICAL CHARACTERISTICS

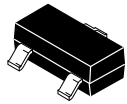

**Figure 13. Safe Operating Area**

# MECHANICAL CASE OUTLINE

## PACKAGE DIMENSIONS

ON Semiconductor®



**SOT-23 (TO-236)**  
CASE 318-08  
ISSUE AS

DATE 30 JAN 2018

SCALE 4:1

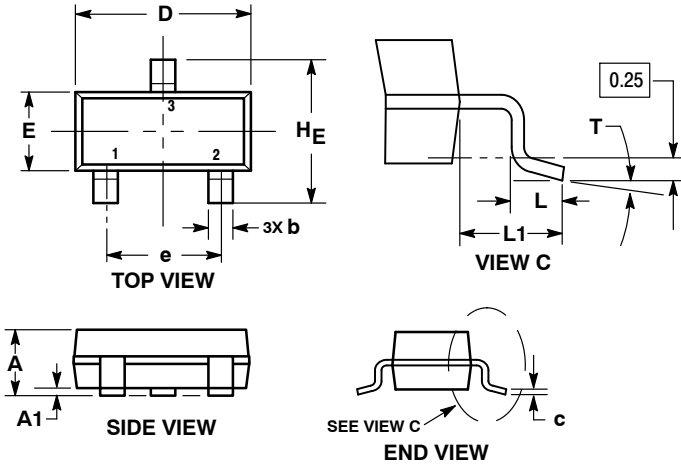

**NOTES:**

1. DIMENSIONING AND TOLERANCING PER ASME Y14.5M, 1994.
2. CONTROLLING DIMENSION: MILLIMETERS.
3. MAXIMUM LEAD THICKNESS INCLUDES LEAD FINISH. MINIMUM LEAD THICKNESS IS THE MINIMUM THICKNESS OF THE BASE MATERIAL.
4. DIMENSIONS D AND E DO NOT INCLUDE MOLD FLASH, PROTRUSIONS, OR GATE BURRS.

DIM	MILLIMETERS			INCHES		
	MIN	NOM	MAX	MIN	NOM	MAX
A	0.89	1.00	1.11	0.035	0.039	0.044
A1	0.01	0.06	0.10	0.000	0.002	0.004
b	0.37	0.44	0.50	0.015	0.017	0.020
c	0.08	0.14	0.20	0.003	0.006	0.008
D	2.80	2.90	3.04	0.110	0.114	0.120
E	1.20	1.30	1.40	0.047	0.051	0.055
e	1.78	1.90	2.04	0.070	0.075	0.080
L	0.30	0.43	0.55	0.012	0.017	0.022
L1	0.35	0.54	0.69	0.014	0.021	0.027
HE	2.10	2.40	2.64	0.083	0.094	0.104
T	0°	---	10°	0°	---	10°

**RECOMMENDED SOLDERING FOOTPRINT**

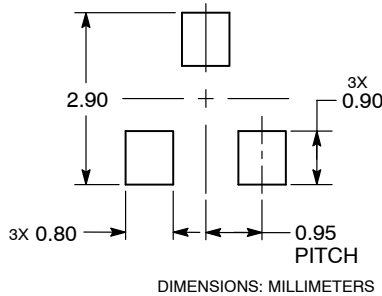

**GENERIC MARKING DIAGRAM\***

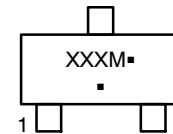

XXX = Specific Device Code  
M = Date Code  
▪ = Pb-Free Package

\*This information is generic. Please refer to device data sheet for actual part marking. Pb-Free indicator, "G" or microdot "▪", may or may not be present.

- |   |   |   |  |
|---|---|---|--|
| STYLE 1 THRU 5:<br>CANCELLED                                | STYLE 6:<br>PIN 1. BASE<br>2. EMITTER<br>3. COLLECTOR       | STYLE 7:<br>PIN 1. EMITTER<br>2. BASE<br>3. COLLECTOR       | STYLE 8:<br>PIN 1. ANODE<br>2. NO CONNECTION<br>3. CATHODE |
| STYLE 9:<br>PIN 1. ANODE<br>2. ANODE<br>3. CATHODE          | STYLE 10:<br>PIN 1. DRAIN<br>2. SOURCE<br>3. GATE           | STYLE 11:<br>PIN 1. ANODE<br>2. CATHODE<br>3. CATHODE-ANODE | STYLE 12:<br>PIN 1. CATHODE<br>2. CATHODE<br>3. ANODE      |
| STYLE 13:<br>PIN 1. SOURCE<br>2. DRAIN<br>3. GATE           | STYLE 14:<br>PIN 1. CATHODE<br>2. GATE<br>3. ANODE          | STYLE 15:<br>PIN 1. GATE<br>2. CATHODE<br>3. ANODE          | STYLE 16:<br>PIN 1. ANODE<br>2. CATHODE<br>3. CATHODE      |
| STYLE 17:<br>PIN 1. NO CONNECTION<br>2. ANODE<br>3. CATHODE | STYLE 18:<br>PIN 1. NO CONNECTION<br>2. CATHODE<br>3. ANODE | STYLE 19:<br>PIN 1. CATHODE<br>2. ANODE<br>3. CATHODE-ANODE | STYLE 20:<br>PIN 1. CATHODE<br>2. ANODE<br>3. GATE         |
| STYLE 21:<br>PIN 1. GATE<br>2. SOURCE<br>3. DRAIN           | STYLE 22:<br>PIN 1. RETURN<br>2. OUTPUT<br>3. INPUT         | STYLE 23:<br>PIN 1. ANODE<br>2. ANODE<br>3. CATHODE         | STYLE 24:<br>PIN 1. GATE<br>2. DRAIN<br>3. SOURCE          |
| STYLE 25:<br>PIN 1. ANODE<br>2. CATHODE<br>3. GATE          | STYLE 26:<br>PIN 1. CATHODE<br>2. ANODE<br>3. NO CONNECTION | STYLE 27:<br>PIN 1. CATHODE<br>2. CATHODE<br>3. CATHODE     | STYLE 28:<br>PIN 1. ANODE<br>2. ANODE<br>3. ANODE          |

<b>DOCUMENT NUMBER:</b>	<b>98ASB42226B</b>	Electronic versions are uncontrolled except when accessed directly from the Document Repository. Printed versions are uncontrolled except when stamped "CONTROLLED COPY" in red.
<b>DESCRIPTION:</b>	<b>SOT-23 (TO-236)</b>	<b>PAGE 1 OF 1</b>

ON Semiconductor and ON are trademarks of Semiconductor Components Industries, LLC dba ON Semiconductor or its subsidiaries in the United States and/or other countries. ON Semiconductor reserves the right to make changes without further notice to any products herein. ON Semiconductor makes no warranty, representation or guarantee regarding the suitability of its products for any particular purpose, nor does ON Semiconductor assume any liability arising out of the application or use of any product or circuit, and specifically disclaims any and all liability, including without limitation special, consequential or incidental damages. ON Semiconductor does not convey any license under its patent rights nor the rights of others.

**onsemi**, **Onsemi**, and other names, marks, and brands are registered and/or common law trademarks of Semiconductor Components Industries, LLC dba "**onsemi**" or its affiliates and/or subsidiaries in the United States and/or other countries. **onsemi** owns the rights to a number of patents, trademarks, copyrights, trade secrets, and other intellectual property. A listing of **onsemi**'s product/patent coverage may be accessed at [www.onsemi.com/site/pdf/Patent-Marking.pdf](http://www.onsemi.com/site/pdf/Patent-Marking.pdf). **onsemi** reserves the right to make changes at any time to any products or information herein, without notice. The information herein is provided "as-is" and **onsemi** makes no warranty, representation or guarantee regarding the accuracy of the information, product features, availability, functionality, or suitability of its products for any particular purpose, nor does **onsemi** assume any liability arising out of the application or use of any product or circuit, and specifically disclaims any and all liability, including without limitation special, consequential or incidental damages. Buyer is responsible for its products and applications using **onsemi** products, including compliance with all laws, regulations and safety requirements or standards, regardless of any support or applications information provided by **onsemi**. "Typical" parameters which may be provided in **onsemi** data sheets and/or specifications can and do vary in different applications and actual performance may vary over time. All operating parameters, including "Typicals" must be validated for each customer application by customer's technical experts. **onsemi** does not convey any license under any of its intellectual property rights nor the rights of others. **onsemi** products are not designed, intended, or authorized for use as a critical component in life support systems or any FDA Class 3 medical devices or medical devices with a same or similar classification in a foreign jurisdiction or any devices intended for implantation in the human body. Should Buyer purchase or use **onsemi** products for any such unintended or unauthorized application, Buyer shall indemnify and hold **onsemi** and its officers, employees, subsidiaries, affiliates, and distributors harmless against all claims, costs, damages, and expenses, and reasonable attorney fees arising out of, directly or indirectly, any claim of personal injury or death associated with such unintended or unauthorized use, even if such claim alleges that **onsemi** was negligent regarding the design or manufacture of the part. **onsemi** is an Equal Opportunity/Affirmative Action Employer. This literature is subject to all applicable copyright laws and is not for resale in any manner.

## PUBLICATION ORDERING INFORMATION

### LITERATURE FULFILLMENT:

Email Requests to: [orderlit@onsemi.com](mailto:orderlit@onsemi.com)

**onsemi Website:** [www.onsemi.com](http://www.onsemi.com)

### TECHNICAL SUPPORT

**North American Technical Support:**  
Voice Mail: 1 800-282-9855 Toll Free USA/Canada  
Phone: 011 421 33 790 2910

**Europe, Middle East and Africa Technical Support:**

Phone: 00421 33 790 2910

For additional information, please contact your local Sales Representative